

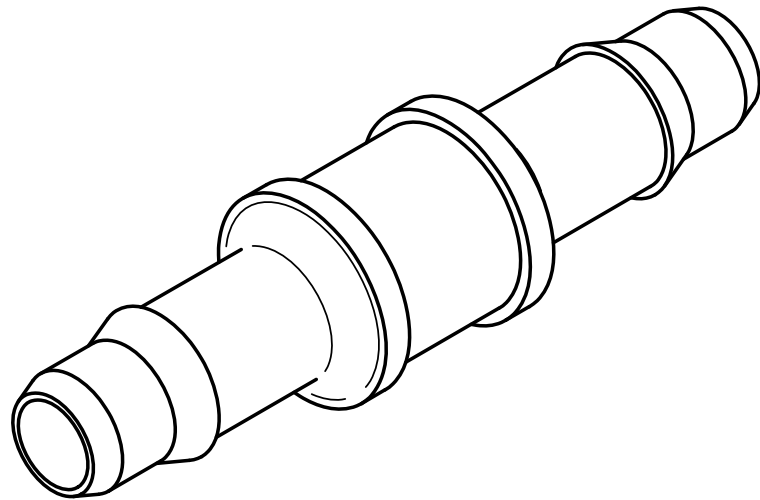

SECTION A-A



REFERENCE ONLY

 Injectech	
TITLE Straight Connector to Rigid 3/32" Barbs	
SIZE A	DWG NO CR332
KSS	DATE 06/27/2017
SCALE: NOT TO SCALE	SHEET 1 OF 1