

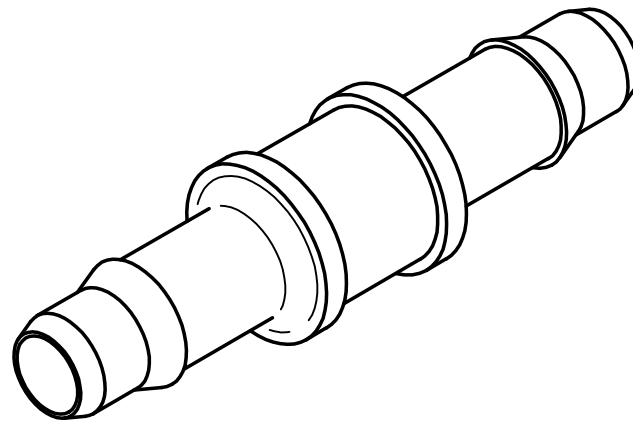

SECTION A-A



REFERENCE ONLY

 Injectech	
TITLE Straight Connector to Rigid 1/8" Barbs	
SIZE A	DWG NO CR18
KSS	DATE 01/24/2018
SCALE: NOT TO SCALE	SHEET 1 OF 1