

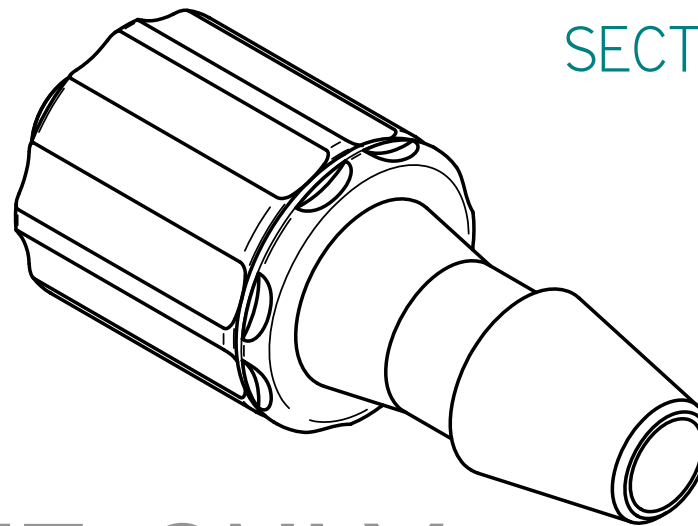

SECTION A-A



REFERENCE ONLY

 Injectech	
TITLE Rotating Male Luer With Snap Ring to 3/16" Barb	
SIZE A	DWG NO A03R316
KSS	DATE 06/27/2017
SCALE: NOT TO SCALE	SHEET 1 OF 1