

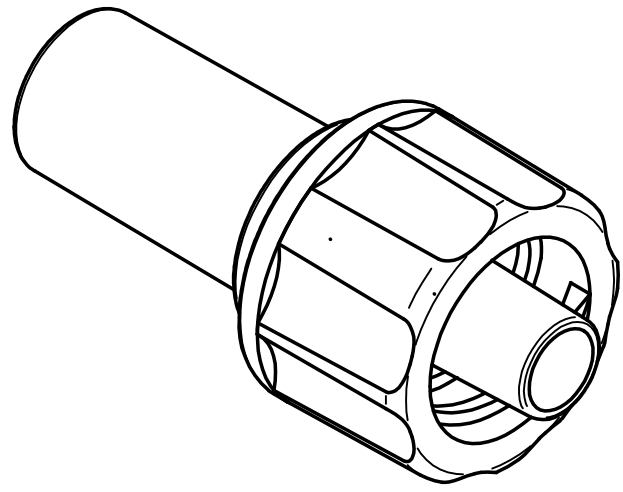

SECTION A-A



REFERENCE ONLY

 Injectech	
TITLE Male Luer Lock Bond-In Port .192/.182	
SIZE A	DWG NO 04B187
KSS	DATE 01/23/2018
SCALE: NOT TO SCALE	SHEET 1 OF 1